

EPS Erasmus Humidifier

Fátima Leal, Mihály Varga, Marc Ribas, Mateusz Małkowski

Abstract— How can an international team make a humidifier for a data center? How can they do it without any previous knowledge about it? They are Erasmus students from Spain, Portugal, Poland and Hungary. They had a lot of problems with this project. Starting from communication, English language and finishing on technical troubles. In this paper it possible to find information about the final product what has been made by us. We had 4 month to make humidifier for data center. We had a lot of requirements. We introduce how it works. What is to do more? Is it a good project?

Keywords— Arduino, compressed air, data center, humidifier, microcontroller, nozzle, web application.

I. INTRODUCTION

Within the European Project Semester at ISEP, it was proposed to build a humidifier with a Web interface. Why does data center need humidifier? The answer is quite easy. In the room with computer devices can't be electric charge. Proper humidity is only one thing what data center wants. The full list of requirements is placed below.

The goal is to develop a humidifier with a Web interface for a server room of 80 m³.

The final product must:

- Maintain of a relative humidity between 40 % and 70 % (+- 5);
- Distribute the generation of water vapor within the room;
- Have two days of autonomy;
- Be placed on the floor of the room;
- Include water and humidity alarms;
- Have an on-off switch;
- Be compliant with the EU Directives 2006/42/CE 2006-05-17 and 2006/95/CE 2006-12-12;
- Have a composite material structure to hold the control unit and the water container;
- Include a life-cycle analysis.

We have as available parameters:

- Air flow;
- Incoming air temperature;
- Chiller input temperature;
- Budget limit: 900 €.

This paper is structured in six chapters. The first chapter is the introduction and presents the problem, the motivation, the objectives, the expected results and the project work plan. The second chapter is the state of the art that describes the options for the construction of all the parts of the humidifier and our choices. The third chapter is the project development and presents the project architecture, the modules, the

functionalities and the tests. The fourth chapter is developed a marketing plan to our product. In this marketing plan is included SWOT and market analysis. The fifth chapter is the conclusion. In this chapter we will describe what we learned with this project, the difficulties encountered and how to overcome them. Finally, in the sixth chapter, the bibliography, we list the references of all sources of information used.

II. STATE OF THE ART

For the construction of our project initially were studied two ideas:

1. Compressed air humidifier;
2. Fan with filter;

Fan filter:

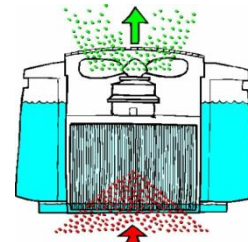

Figure 2: Humidifier with fan

The bottom of this filter is under the water so it can soak up that so the whole filter will be wet. A ventilator working above this filter and moving the air of the room through the wet filter increase that humidity. If in the room the humidity is low more water will vaporize, if there is high humidity the vaporization is slower. In this method without any control the humidity is stabilizes around 50-60%. But with the speed of the ventilator we can take control. The advantage of this type of humidifier: silent, not need much energy or difficult control, and need simple materials, makes perfect vapor. The disadvantage: against the scale we must use distilled water, and because it circulating the room air it need a pre-filter to keep clean the vaporization filter and some time it need to be cleaned, but for exchange it makes cleaner the air too.

Compressed air humidifier:

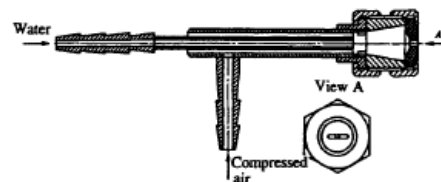

Fig. 1. Schematic diagram of pneumatic nozzle.

Figure 1: Schematic diagram of pneumatic nozzle

Pneumatics is a technology, which use of [pressurized gas](#) to effect mechanical motion.

1) The nozzle is equipped with a tip in which an element of a mechanical plane-cone nozzle is used. A fiat gas-liquid cone of dropping liquid is formed as a result of the special profile of the diaphragm opening at the outlet from the nozzle. [4]

2) There are compressors that use rotating impellers to generate air pressure; positive-displacement compressors are more common. Air pressure is increased by reducing the size of the space that contains the air.

Like a small internal combustion engine, a conventional piston compressor has a crankshaft, a connecting rod and piston, a cylinder and a valve head. The crankshaft is driven by either an electric motor or a gas engine. While there are small models that are comprised of just the pump and motor, most compressors have an air tank to hold a quantity of air within a preset pressure range. The compressed air in the tank drives the air tools, and the motor cycles on and off to automatically maintain pressure in the tank.

At the top of the cylinder, you'll find a valve head that holds the inlet and discharge valves. Both are simply thin metal flaps—one mounted underneath and one mounted on top of the valve plate. As the piston moves down, a vacuum is created above it. This allows outside air at atmospheric pressure to push open the inlet valve and fill the area above the piston. As the piston moves up, the air above it compresses, holds the inlet valve shut and pushes the discharge valve open. The air moves from the discharge port to the tank. With each stroke, more air enters the tank and the pressure rises.

Compressors use a pressure switch to stop the motor when tank pressure reaches a preset limit—about 125 psi for many single-stage models. Most of the time, we though, you don't

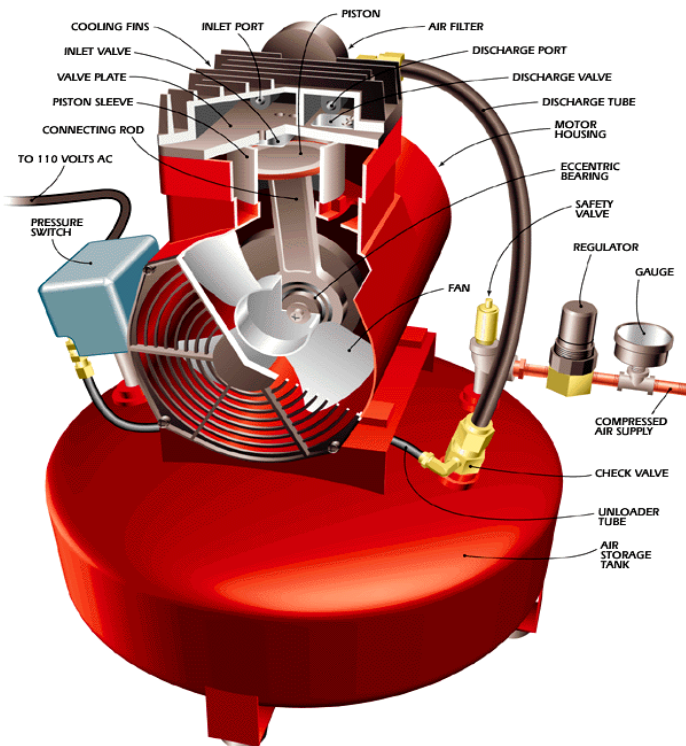

Figure 3: Parts of a compressor

need that much pressure. Therefore, the air line will include a regulator that you set to match the pressure requirements of the tool you're using. A gauge before the regulator monitors tank pressure and a gauge after the regulator monitors air-line pressure. In addition, the tank has a safety valve that opens if the pressure switch malfunctions. The pressure switch may also incorporate an unloader valve that reduces tank pressure when the compressor is turned off. [5]

With these two ideas studied we chose to compressor idea because we did not have absolute certainty that another idea would meet the objectives proposed. The idea of compressed air would be safer and more effective.

3) For control the humidifier we found two solutions: the microcontroller with Arduino and PLC. Microcontrollers are typically used in automation and control products and peripherals, as systems of automotive engine control, remote controls, residential and office machines. PLCs are based on microcontrollers which allows solutions far economic. The current can be networked, often with private protocols of each manufacturer. It is increasingly common to use the Ethernet for connecting computers and PLC. The final decision is to



Figure 4: Arduino

use the microcontroller insured in a small application called arduino. For this decision we thought in applications and the price.

4) The web interface was developed with Java. The language derives much of its syntax from C and C++ but has a simpler object model and fewer low-level facilities. Java is currently one of the most popular programming languages in use, and is widely used from application software to web applications. For the interconnection of various parts of the Web interface we will use the following software:

- ✓ Tomcat
- ✓ MySQL
- ✓ Notepad ++

III.PROJECT DEVELOPMENT

1) We have decided that we want to make compressed air humidifier. We thing it is the best connection of price and performance. The disadvantages of this option are volume and big size of container. We have bought a compressor what generate 66 dB. We also have very efficient nozzle. There are two important parts in our humidifier. We don't need any pump because the pressure is enough to sack water from the

container. The idea of working humidifier shows the graphic below. We also give the most important specification of the parts.

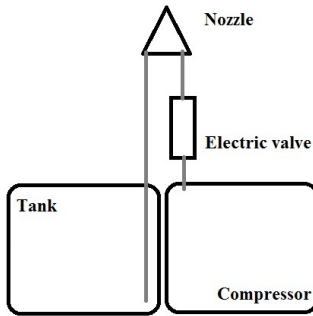

Figure 5: Sketch of the humidifier

Compressor:

- Producer:** ABAC
 - Name:** Vento 2002
 - Volt:** 230/240
 - Watt:** 750
 - Max pressure [bar]:**8
 - Silent:** 66 dB
 - Capacity of the air tank [l]:** 6
 - Dimensions [mm]:** 530x210x540
 - Weight [kg]:** 9
- Photo:



Figure 6: Our compressor[1; 3]

We also decide to use special nozzle for humidifier.

Producer: Isofluido's Lechler Nozzle

- Name:** 136.330.35.16
 - Q:** [l/h] 1,2 (4bar)
- Photo:



Figure 7: Our nozzle [2]



Figure 8: Water tank

The water will be consumed by nozzle will be stored in a tank. The volume of the tank will have capacity for two days of autonomy as the initial specifications of the customer. First we calculated that the 80m³ air how much water the air contains in the same temperature but in different percentage. After, we made it for the all temperature what occurred in the data center. Later by taking these numbers into a table we could easily calculate how many water we need to raise the humidity from one point to the other. Unfortunately the datacenters measurements has not enough changes and we could not make tests in the room, so we couldn't calculate the exact amount what we need for 2 days. Than we chose the tank to be enough for the worst case for two days. [9]

For 80m ³	19°C	20°C	21°C	22°C	23°C	24°C	25°C
Relativ humidity							
10%	126,4	136	145,6	155,2	164,8	174,4	184
20%	252,8	272	291,2	310,4	329,6	348,8	368
30%	379,2	408	436,8	465,6	494,4	523,2	552
40%	505,6	544	582,4	620,8	659,2	697,6	736
50%	632	680	728	776	824	872	920
60%	758,4	816	873,6	931,2	988,8	1046,4	1104
70%	884,8	952	1019,2	1086,4	1153,6	1220,8	1288
80%	1011,2	1088	1164,8	1241,6	1318,4	1395,2	1472
90%	1137,6	1224	1310,4	1396,8	1483,2	1569,6	1656
100%	1264	1360	1456	1552	1648	1744	1848

Figure 9: Table to calculate the water

2) As almost all of equipment our humidifier will have a control. The control was divided into several parts:

1. Water level (Tank)
2. Humidity control
3. Local humidity sensor
4. Internet connection

Throughout the construction of the program appeared new aspects that were needed for the success of the final product like:

5. Send an email with information on water level
6. Check the date and time

At the beginning we were a little lost because we did not know how to begin. As a first step we build a small diagram that interconnected all parts of the code as shown in the following figure that was improved on over time. . The next step was to build a flowchart.

The code consists in six steps mentioned above. Not to get too complex we divide the code into three files. The first is the hardware initialization, control of moisture and control the water level. The second file is the connection to the server to receive the data of humidity and test the validity of data based on the date and time. The third file is the connection to the mail server which will send an email when the tank water level is zero. As a final result we obtained the control of moisture and water level of our product. [6]

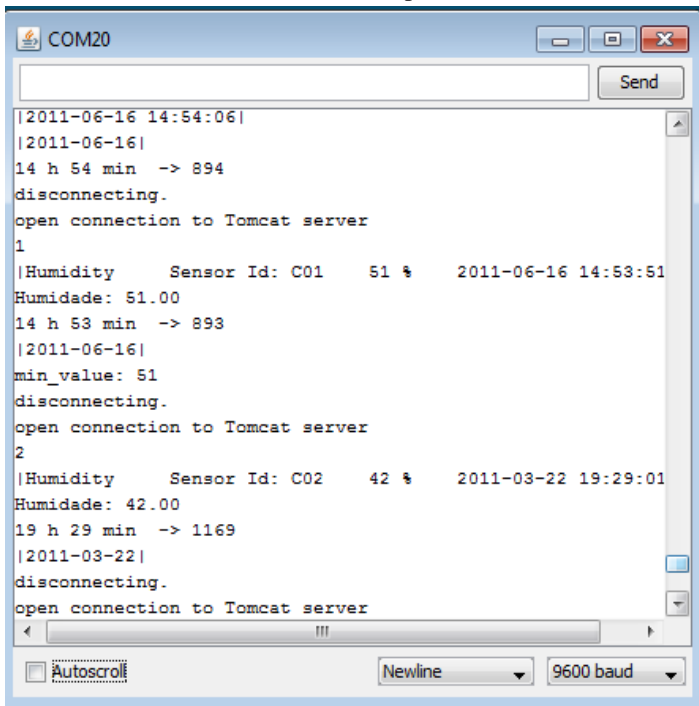

Figure 10: Getting the datas

To control the humidity we focus the average amount of desired humidity 55%. When the humidity is smaller than 55% the valve that



Figure 11: Valve

controls the air humidifier is turned on and operational. Otherwise the valve will not activate.

The moisture value is sent to the Arduino via Internet as mentioned earlier. If there is network failure we use a humidity sensor location that was designed for this purpose. [10]



Figure 12: Humidity sensor

For the circuit we had to take into account the characteristics of the components used: electric valve and arduino and we divided the circuit in four parts:

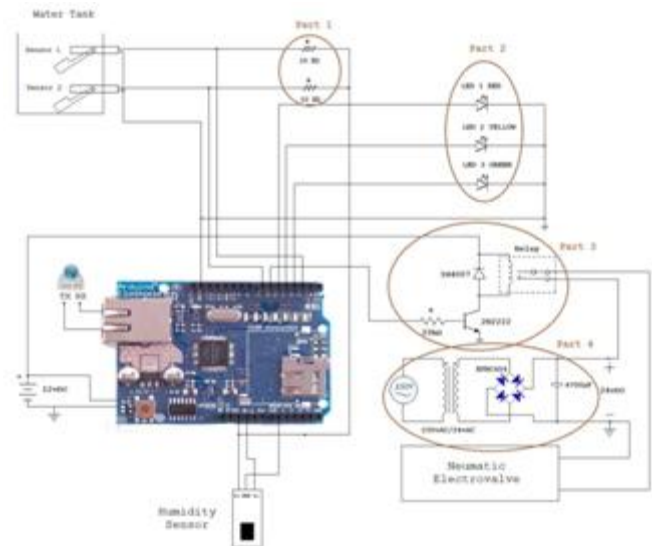

Figure 13: Electric circuits

The first part consist in to control the water sensor using the pullup resistors of 10 kΩ.

The second part is to obtain some information on the operational status of the humidifier we put three LEDs that give us information of three different things:

- LED 1 red – Empty tank
- LED 2 yellow – Lack of water
- LED 3 green – Internet is working

The third and fourth parts of the circuit are to control electric valve. The part 4 of the circuit is for convert 230V AC to 24V DC because the valve needs 24V DC. For this we used a transformer 230V (AC) – 24V (AC). Graetz bridge and condensator convert AC to DC. The part 3 of the circuit is for to control the electric valve using the relay and doing the following calculations for calculate the resistor of 33 kΩ:

$$R_{coil} = 1 \text{ k}\Omega; V = 12 \text{ V}; I = \frac{12}{1000} = 12 \text{ mA} = I_c$$

Using the transistor 2N2222 – BC548 with $h_{fe} = 75$

$$h_{fe} = \frac{I_c}{I_b} \leftrightarrow I_b = \frac{I_c}{h_{fe}} = \frac{0.012}{75} = 0.16 \text{ mA}; \quad R = \frac{V_{arduino}}{I_b} = \frac{5}{0.00016} = 31250 \Omega$$

With this result the real resistor that was closer to the calculations was the 33 kΩ.

3) The container will contain all parts of our product. To get an idea of how we would get at beginning of the project we did the following drawing. However, the design was modified over time because the ideas were changing in accordance the project development.

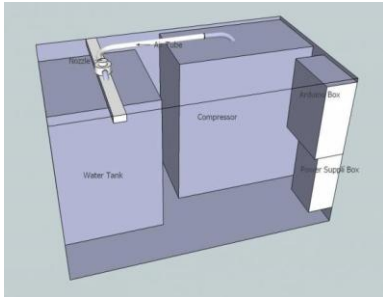

Figure 14: Plan of the container



Figure 15: Container in real

Results:

The Humidifier will work during 30 s and it will be stopped during 5 minutes. For test, we tested during 30 min the evolution of humidity in our little room F314.

Time	Humidity
0 min	45 %
+5 min	47 %
+ 5 min	50 %
+5 min	52 %
+5 min	53 %
+5 min	54 %
+ 5 min	55 %

Table 1: Test results in room F314

We can conclude that the humidity in our room F314 increased 10 % in 30 minutes without air circulation. Otherwise will happen in the data center where we will have air circulation in which we will get a faster-wetting.

4) The web interface will identify the sensors and life-cycle analysis of the humidity and temperature. The web interface is the tool that people use to see the development of moisture throughout the day. In a first contact with the language we

develop a small and simple program to test the interconnection and compiling of software. We didn't create the Web interface, however, we learned some basics of Java language. [8]

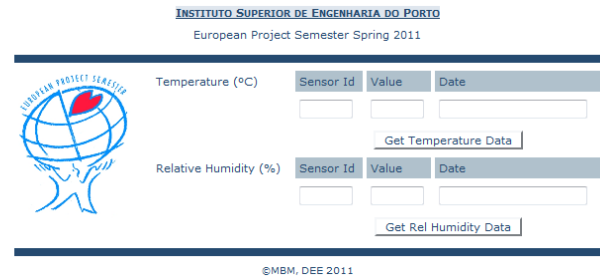

Figure 16: Web interface

IV.MARKETING PLAN

With product done we will have to put it in the market. This marketing plan was developed with the purpose of market research, who would be the main customers, short-term goals and developing strategies that would help the product succeed in the market. This marketing plan includes a first analysis of the market. This part is the explicit description of the product and the main competitor. Then will state one of the most important parts of this plan marketing strategy and objectives, tactical marketing programs. In the last part of the marketing mix that studies the politics of the four p's. The lack of moisture in certain situations is very harmful to industrial equipment such as data centers but also for health. The thinking in these situations our product will be easily adapted to customer needs.

A.Situational analysis (Market analysis)

a) Current Target Market

The market of data center humidifiers is very complicated. It is a small market because it don't have many applications in daily life. In little applications the client buy the humidifier in any place without difficulty. In others applications, in applications with bigger dimension the buyer can't check the prices easily. The client have to call to company and make an appointment. We can reach more people if we make some instruction to how can they calculate the price for their need. In our case, there are few brands that sell all stuff for data centers. The main strategy of the sellers of humidifiers is the internet so do our will be. The internet is the firts place if someone wnat to search for something, this is the fastest way to take the contact between the costumers and us. And last but not least this is the cheapest way to offer our products. But a shop has many advantages like there the customers can see what they want or can ask in live. So the further plan can be that to open a shop. Until we don't have shop we need to offer to deliver our product, but in this way we can reach more costumer.

As our product was performed to data center we study where could find data centers in Portugal:

We can find data centers in:

- Port offices

- Business Centers
- Shopping Malls
- Universities
- Hospitals
- Banks

These places can be the our clients and potentially interested in our product.

b) *Current Competitors*

This moment one the competitor in Porto that we found is “JS HUMIDIFICADORES O ESPECIALISTA DA HUMIDIFICAÇÃO”. However exist many place where we can find humidifiers like:

- Supermarkets
- Appliances shops, etc...

B. Marketing Strategy and Objectives, tactical Marketing Programs

We want to sell product only by the internet because we think that the best way to promotion our product. So, we will create internet shop for only one product. The web page will be in 4 languages: Polish, Portuguese, Spanish, and English. We will pay for position in Google. We must write instruction how to run and use humidifier and we will give out-door guaranty for 1 year. Delivery by the courier. This is humidifier special for data centers. However we can adapt the humidifier for another application that the costumer wants. We are developing a humidifier with Web interface and two days autonomy for the ISEP data center with 80 m2. This is an example that we can, not only developing any humidifier, but also to do the control and some software depending on the desired application. This is an important strategy because it can cause more customers are interested in our products for their businesses, offices or even homes. For our product we have the following objectives and strategy:

Objectives (“GOALS, which determine the focus”)

1. Increase brand recognition above 80% (client)
2. Maintain customer satisfaction rate above 90%
3. Launch new communications campaign to reach at least 80% of target
4. Achieve operational excellence in the internal processes of marketing, supplier, product development, logistics, social and environmental programs
5. Attract and retain talent

Strategy (Strategy is the production of plans to achieve goals)

1. Win at least two new markets
2. Increase the portfolio of products and services. Launch two new kinds of products in the year
3. Lower prices to attract buyers to track price sensitive
4. Being competitive

5. Young and innovative ideas

Tactical marketing programs

- Telemarketing promoting special discounts for new customers
- Participate in events for disclosure of the product (fairs)
- Increase customers' credit assets
- Modern advertising methods

Problem with lack of moisture ... EPS project is the solution.

C. Marketing Mix

a) Product: Costumer:

The product is a humidifier done for areas between 80 m2. This humidifier is done with a silent compressor and nozzle that spreading humidity very effectively. The production is conducted in Instituto Superior de Engenharia do Porto by students of the European Semester Project. A young team with innovative ideas. The product was developed for data centers or industrial places that need moisture. How is industrial product, the design is not very relevant but the occupied space (round one square meter), the noise produced (66 dB) and autonomy (controlled as desired). The product contains the control with a Web interface to achieve the moisture that is desired as the autonomy that the client wishes. This is a new product with a new brand called “EPS” but it is innovative and dynamic, that is, easily adapts to all types of situations involving fata humidity.

b) Price: Cost:

The process of setting a price for the product, is for most companies a difficult process always thinking about the profit they can enjoy. Our definition of price was tied wondering if and only on the client. ***Our price offers a good cost benefit ratio.*** The our product have the following **prices**:

- With Web interface - 1199,99 € with 23% VAT included
- Without Web interface - 999,99 € with 23% VAT included

The price includes VAT but not the shipping.

However the customers who purchase 5 units of our product we offer a discount of 5%. The customers who purchase more than 10 units of our product we offer a discount of 10%. Deliveries in Portugal are free.

The forms of payment available are:

- Prepayment;

- Transfer;
- Check;
- Credit Card and Online Transfer;

For customers living outside of Portugal: (In these situations, the price will be adjusted according to exchange rates)

- Credit Card and PayPal.

The payment will be facilitated to customer preference.

c) Place: Convenience:

We want to sale it mainly on the internet and deliver our product freely in portugal and in world. We planning to sale the product only by ourselves on the internet, we don't want to use other trading companies. To do this we will create a website on the internet that can be accessed in four languages: Portuguese, Polish, Hungarian and Spanish and we can be visited for all people of world. This way the customer will have access easily to all product data, how to buy and the means of payment is fairly easy, effective and convenient.

d) Promotion: Communication:

For the sale of our product to take place we need to disclose it. The main medium is advertising. Not only do we get to each individual person but also the major industries that are likely to buy our product. Then, for to promote the product will take into account:

Portugal

- Advertising mail for industries or institutions that may purchase the product;
- Participation in fairs and commercial initiatives;
- Promotion of lectures in various parts of the country for better contact with potential customers by answering questions timely;
- Preparation of publicity material for distribution.

Rest of the world

- Advertising mail for industries or institutions that may purchase the product;
- Internet;
- Competitive discounts to large customers;
- Participation in fairs and commercial initiatives.[7]

V.CONCLUSION AND FUTURE DEVELOPMENTS

Our humidifier has one very important advantage and also few disadvantages. The plus point is that it is efficient. The problem is with the size of the container. It is not very convenient. It could be better. The volume of our humidifier

is 66 dB. It is very loudly but it shouldn't be a big problem in the close room where is a lot of noisy equipment.

Things what should be done in this humidifier:

- System to remove water pollution. It could be chemical compound or UV lamp.
- Composite material structure.
- size of container could be reduce or better construction of container(higher than wider)
- Turn volume down
- The mail box where will be sent with information of water level of the humidifier tank should be consulted frequently.
- The compressor should be checked every 24 hours of operation because the deposit will have to be purged. For this, will be sent an email with this information.

We can conclude that was an interesting project and we had an opportunity to confront real life. The trickiest part was the choice of material and its specifications sometimes committing errors in which we shall acquire equipment that we do not need, or material not compatible with the specifications of the project. The communication and teamwork was very difficult in beginning but we improving over time. During these months we discovered that the key to success "is doing what the other person does not want to do:

- Work long and hard
- Criticize and accept criticism
- Become involved"

We want to say thank you for all supervisors who helped us to our success in the EPS Project.

VI. REFERENCES

- [1] – ABAC, AIR COMPRESSOR, AVAILABLE AT [HTTP://WWW.ABAC.CO.UK/COMPRESSORS/VENTO2002.HTM](http://www.abac.co.uk/COMPRESSORS/VENTO2002.HTM), ACCESSED IN JUNE 2011.
- [2] – LECHER, PNEUMATIC NOZZLES, AVAILABLE AT [HTTP://PDF.DIRECTINDUSTRY.COM/PDF/LECHLER/PNEUMATIC-NOZZLES/SHOW/7037-33704-_3.HTML](http://PDF.DIRECTINDUSTRY.COM/PDF/LECHLER/PNEUMATIC-NOZZLES/SHOW/7037-33704-_3.HTML), ACCESSED IN JUNE 2011.
- [3] – ABAC, BRICOLANDIA, AVAILABLE AT [HTTP://WWW.BRICOLANDIA.ES/ABAC-VENTO-SILENT-OM-200-COMPRESOR-DE-AIRE-SIN-ACEITE-OM200/](http://WWW.BRICOLANDIA.ES/ABAC-VENTO-SILENT-OM-200-COMPRESOR-DE-AIRE-SIN-ACEITE-OM200/), ACCESSED IN JUNE 2011.
- [4]- SPRINGERLINK, PNEUMATICS, AVAILABLE AT [HTTP://WWW.SPRINGERLINK.COM/CONTENT/X234442701346184/](http://WWW.SPRINGERLINK.COM/CONTENT/X234442701346184/), ACCESSED IN JUNE 2011.
- [5]- POPULAR, MECHANICS, AVAILABLE AT [HTTP://WWW.POPULARMECHANICS.COM/HOME/IMPROVEMENT/ENERGY-EFFICIENT/1275131](http://WWW.POPULARMECHANICS.COM/HOME/IMPROVEMENT/ENERGY-EFFICIENT/1275131), ACCESSED IN JUNE 2011.
- [6]- ARDUINO, ARDUINO, AVAILABLE AT [HTTP://WWW.ARDUINO.CC/](http://WWW.ARDUINO.CC/), ACCESSED IN MAY 2011.
- [7]- MARKETING, MARKETING, AVAILABLE AT [HTTP://WWW.BRANDME.COM.BR/OBJETIVOS/](http://WWW.BRANDME.COM.BR/OBJETIVOS/); ACCESSED IN MAY 2011.
- [8] - JAVA, LANGUAGE, AVAILABLE AT [HTTP://WWW.JAVA.COM/EN/DOWNLOAD/FAQ/WHATIS_JAVA.XML](http://WWW.JAVA.COM/EN/DOWNLOAD/FAQ/WHATIS_JAVA.XML), ACCESSED IN APRIL 2011.
- [9]- RSONLINE, WATER SENSOR, AVAILABLE AT [HTTP://PT.RSONLINE.COM/WEB/SEARCH/SEARCHBROWSEACTION.HTML?METHOD=SEARCHPRODUCTS&SEARCHTERM=SENSOR+DE+NIVEL+DE+%C3%A1GUA&X=0&Y=0](http://PT.RSONLINE.COM/WEB/SEARCH/SEARCHBROWSEACTION.HTML?METHOD=SEARCHPRODUCTS&SEARCHTERM=SENSOR+DE+NIVEL+DE+%C3%A1GUA&X=0&Y=0), ACCESSED IN MARCH 2011.
- [10] - INMOTION, HUMIDITY SENSOR, AVAILABLE AT [HTTP://WWW.INMOTION.PT/STORE/PRODUCT_INFO.PHP?CPATH=17_31&PRODUCTS_ID=305](http://WWW.INMOTION.PT/STORE/PRODUCT_INFO.PHP?CPATH=17_31&PRODUCTS_ID=305), ACECSSED IN MARCH 2011.
- [11] – MANUTAN,COMPRESSOR, AVAILABLE AT [HTTP://WWW.MANUTAN.PT/COMPRESSORES-PORTATEIS-COMPACTOS-COMPRESSOR-SILENCIOSO-DE-6-L O-04679-750.HTML](http://WWW.MANUTAN.PT/COMPRESSORES-PORTATEIS-COMPACTOS-COMPRESSOR-SILENCIOSO-DE-6-L O-04679-750.HTML), ACCESSED IN MARCH 2011.